

Article number: 25220265002

Description: ICME Single-phase motor MD100 B2 2,2KW
2 - 2800 rpm 1x230 Volt 50Hz B14 with starting & running capacitor

Measures

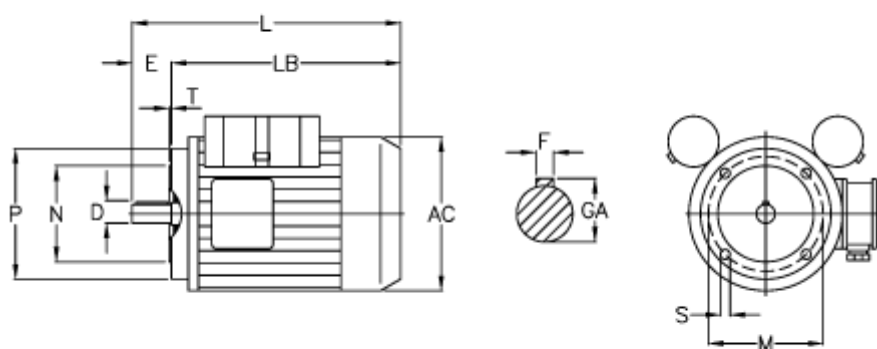

AC = 195	M = 130
D = 28	N = 110
E = 60	P = 160
F = 8	S = M8
GA = 31	T = 3.5
HB = 140	Z = 260
L = 403	
LB = 343	